

Frame 3 AC Electric Winch

Parts Breakdown

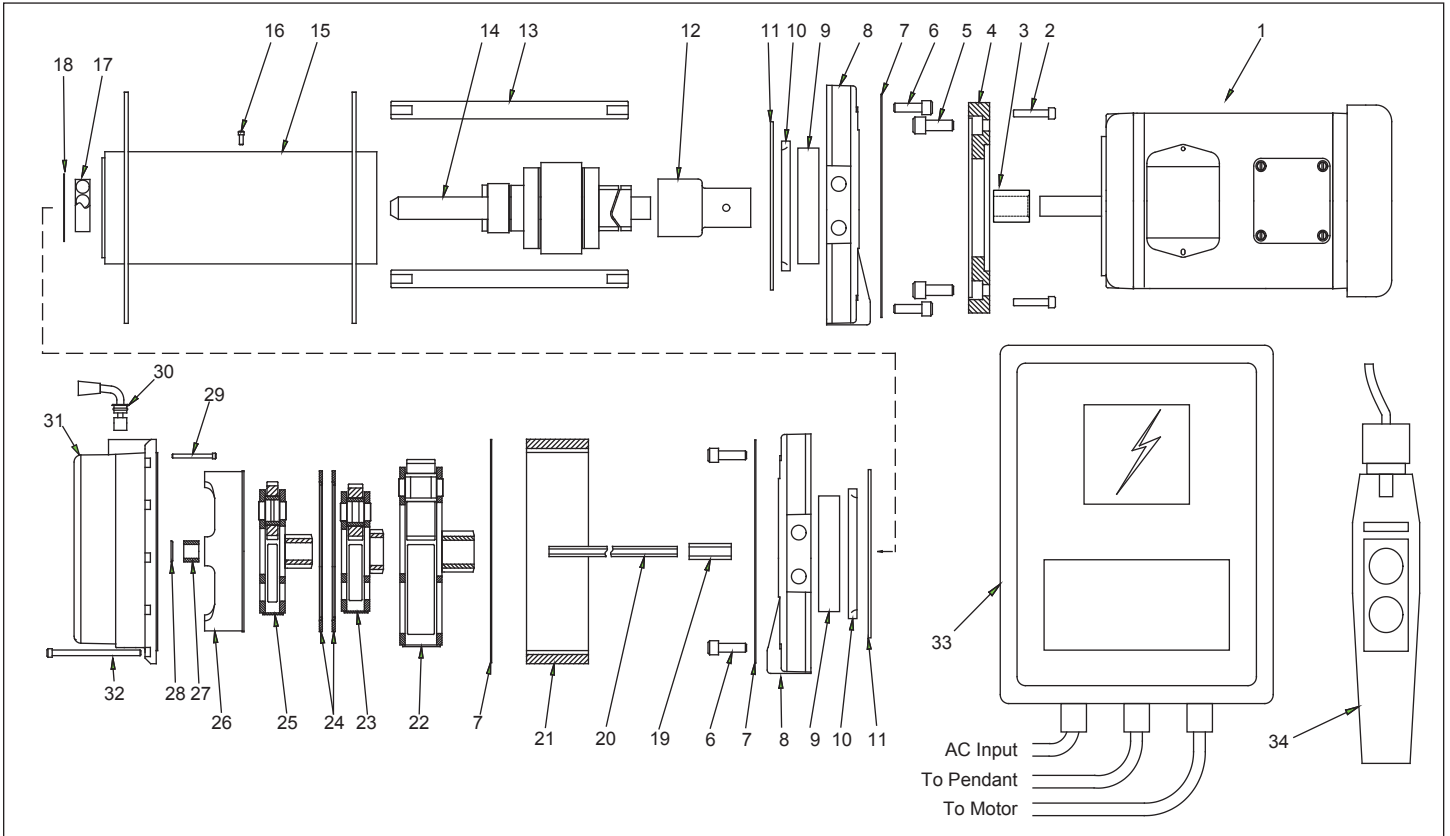

Parts List

WG3700-4A34-L-03

Item	Part Number	Qty.	Description	Item	Part Number	Qty.	Description
1	VM3545	1	AC Electric Motor	21	31679	1	Ring Gear
2	-----	10	1/4-20 x 1-1/4" SHCS	22	30335	1	3rd Stage Carrier
3	MC1057	1	Spacer	23	24563	1	2nd Stage Carrier
4	MC1065	1	Motor Adapter	24	15581	2	Retaining Ring
5	-----	4	3/8-16 x 3/4" SHCS	25	15643	1	1st Stage Carrier
6	-----	6	3/8-16 x 1-1/4" SHCS	26	34837	1	Clutch Gear
7	14964	3	Gasket	27	24832	1	Sun Gear
8	31675	2	Drum Support	28	64252	1	Thrust Plug
9	30274	2	Drum Bushing	29	16086	1	Clutch Retainer
10	30275	2	Seal	30	39928	1	Freespool Lever
11	30277	2	Thrust Washer	31	31684	1	Gear Housing Assembly
12	MC1011	1	Coupler	32	-----	10	1/4-20 x 3" SHCS
13	31288	3	Tie Rod	33	MC1008A	1	Control Box
14	-----	1	Drum Brake	34	MC1230	1	Low-Voltage Pendant
15	32225	1	Drum				
16	36974	1	Set Screw				
17	31672	1	Bearing/Tolerance Ring				
18	3000-X187	1	Snap Ring				
19	30329	1	Drive Shaft Adapter				
20	30315	1	Drive Shaft				