

Frame 1 Pneumatic Winch

Parts Breakdown

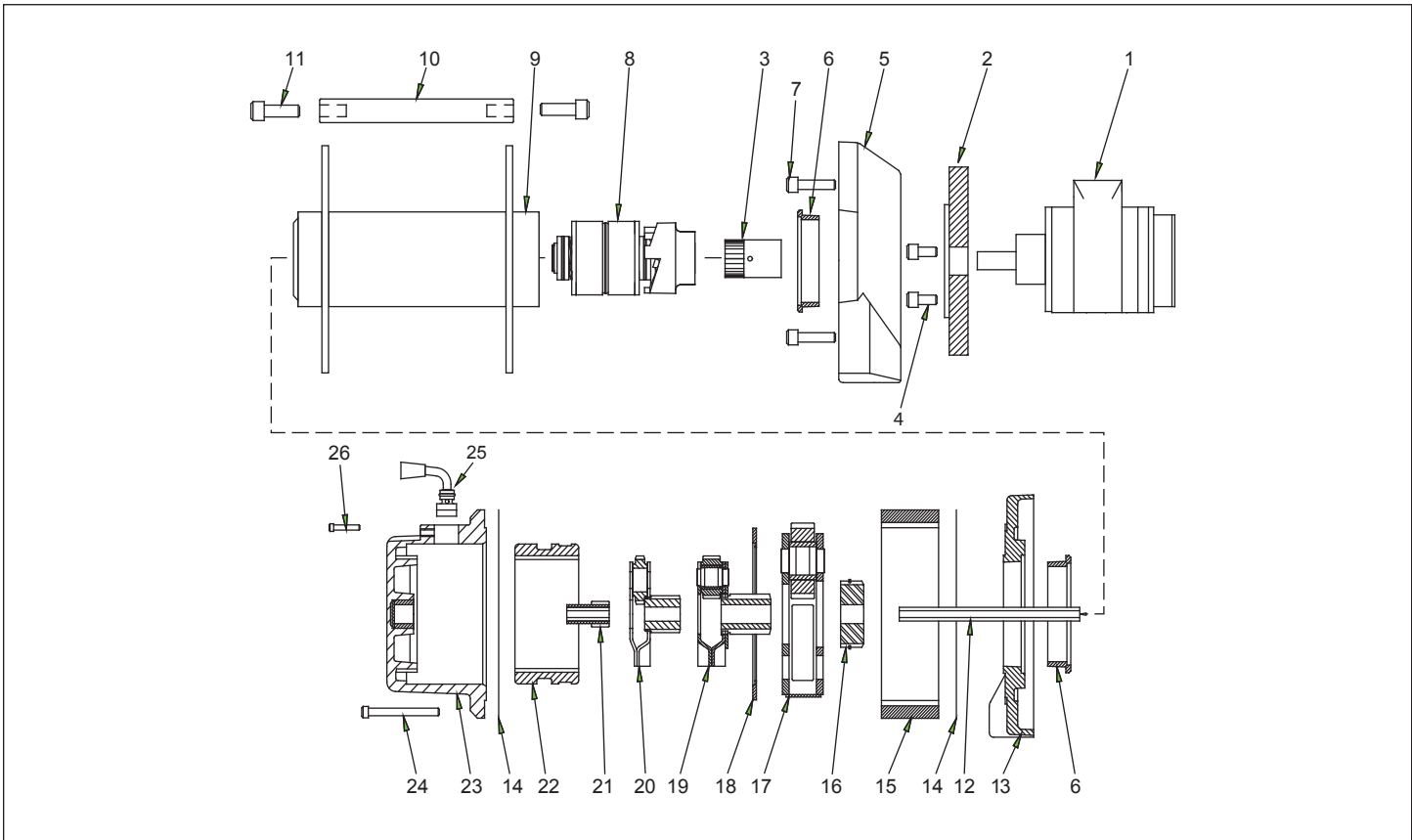

Parts List

WD2000-P-02

Item	Part Number	Qty.	Description
1	VA4JXXX10	1	Pneumatic Motor
2	MC1015	1	Motor Adapter
3	MC1007	1	Coupling
4	-----	3	1/4-20 X 1/2" SHCS
5	31610	1	Drum Support
6	13831	2	Drum Bushing
7	-----	4	1/4-20 X 1" SHCS
8	13799	1	Drum Brake
9	26107	1	Drum
10	32408	2	Tie Rod
11	-----	4	5/16-18 X 1" SHCS
12	-----	1	5/16" X 10.53" hex shaft
13	34506	1	Drum Support
14	13848	2	Gasket
15	25308	1	Ring Gear
16	14584	1	Planetary Gear Coupler
17	28432	1	3rd Stage Carrier
18	13826	1	Nylon Thrust Washer
19	34342	1	2nd Stage Carrier
20	34339	1	1st Stage Carrier

Item	Part Number	Qty.	Description
21	13874	1	Sun Gear
22	28353	1	Sliding Ring Gear
23	27337	1	Gear Housing
24	-----	10	#10-24 X 2-1/4" SHCS
25	68611	1	Freespool Lever
26	13872	1	Clutch Retainer