

Frame 2 Pneumatic Hoist

Parts Breakdown

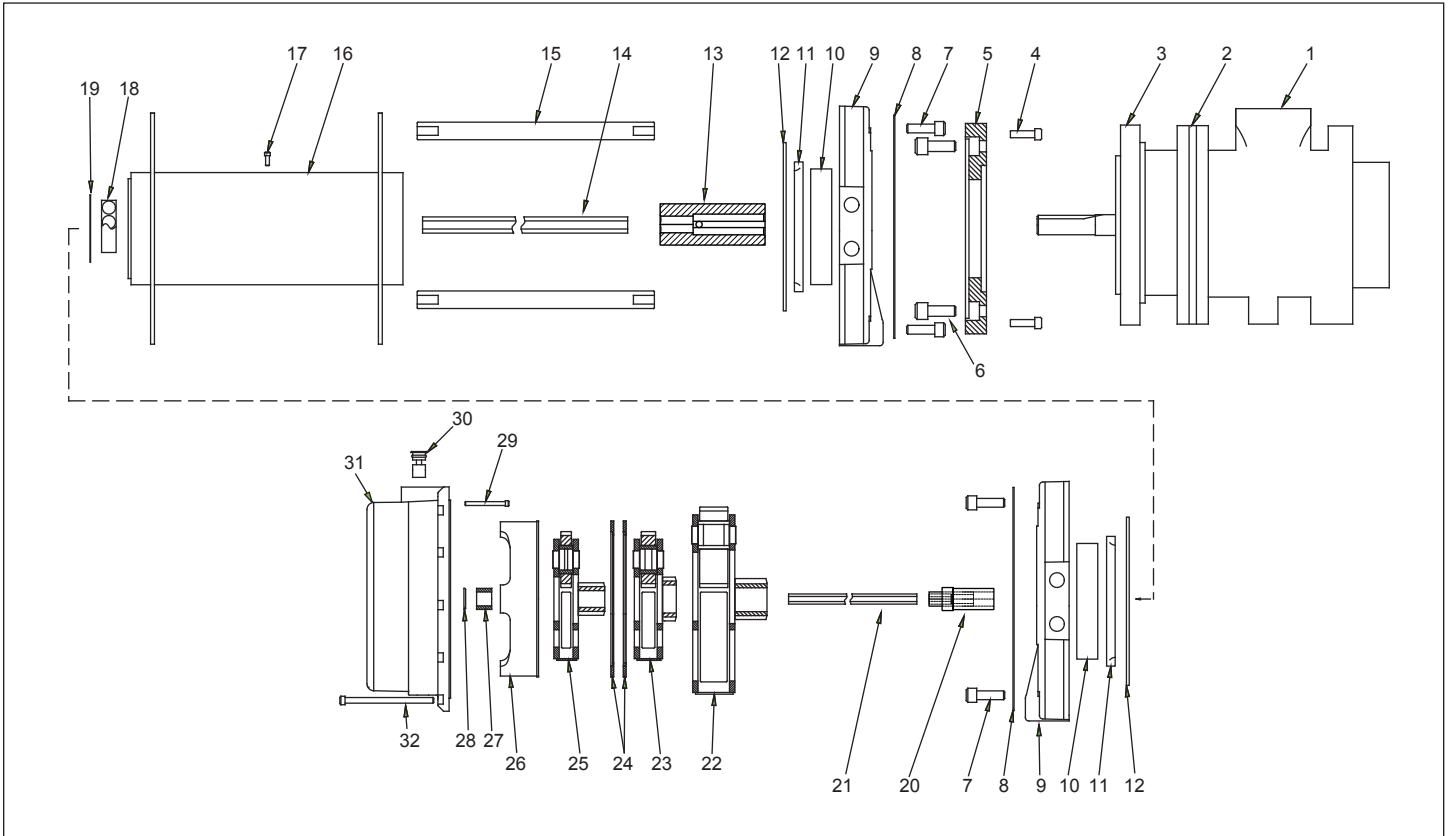

Parts List

HF3150-P-03

Item	Part Number	Qty	Description	Item	Part Number	Qty	Description
1	VA6CXXX10	1	Pneumatic Motor	21	MC1226	1	5/16" hex drive
2	MC1112	1	Spacer	22	30310	1	3rd Stage Carrier
3	625SB-CCX10	--	Pneumatic Brake	23	18598	1	2nd Stage Carrier
4	-----	10	1/4-20 x 1-1/4" SHCS	24	15581	2	Retaining Ring
5	MC1065	1	Motor Adapter	25	15654	1	1st Stage Carrier
6	-----	4	3/8-16 x 3/4" SHCS	26	34837	1	Clutch Gear
7	-----	6	3/8-16 x 1-1/4" SHCS	27	19574	1	Sun Gear
8	14964	2	Gasket	28	64252	1	Thrust Plug
9	31675	2	Drum Support	29	36634	1	Clutch Retainer
10	30274	2	Drum Bushing	30	23667	1	Freespool Blockout
11	30275	2	Seal	31	31676	1	Gear Housing Assembly
12	30277	2	Thrust Washer	32	-----	10	1/4-20 x 1-1/4" SHCS
13	MC1223	1	Coupler				
14	MC1234	1	1/2" hex drive				
15	31288	3	Tie Rod				
16	32225	1	Drum				
17	36974	1	Set Screw				
18	31672	1	Ball Bearing				
19	3000-X187	1	Snap Ring				
20	MC1225	1	Adapter				