

Frame 1 AC Electric Hoist

Parts Breakdown

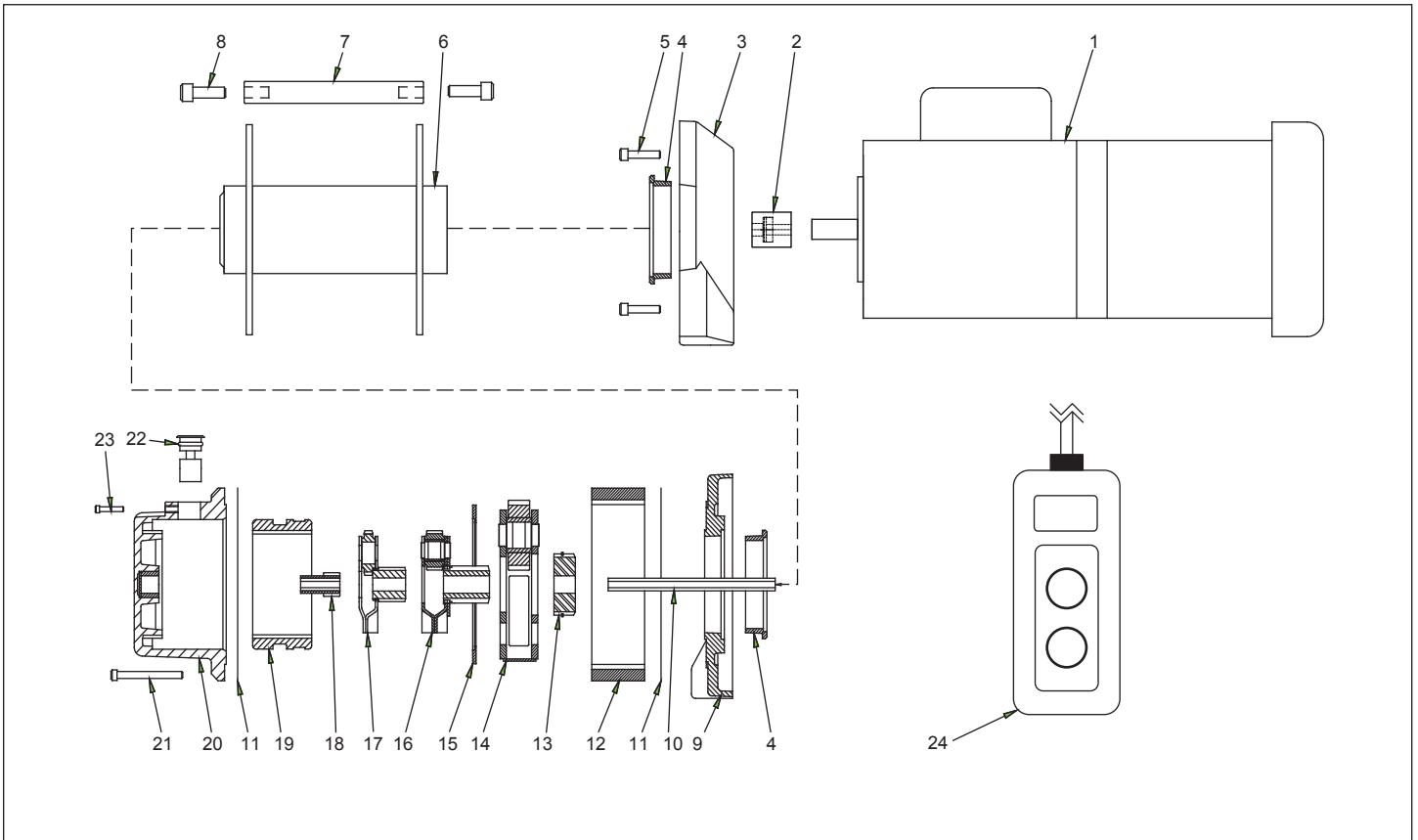

Parts List

HD1450-1A34-F-02

Item	Part Number	Qty.	Description
1	34K828-0068G1	1	Brakemotor
2	MC1028	1	Coupling
3	31610	1	Drum Support
4	13831	1	Drum Bushing
5	-----	4	1/4-20 X 1" SHCS
6	26107	1	Drum
7	32408	2	Tie Rod
8	-----	4	5/16-18 X 1" HHCS
9	34506	1	Drum Support
10	MC1218	1	Drive Shaft
11	13848	2	Gasket
12	25308	1	Ring Gear
13	14584	1	Planetary Gear Coupler
14	28432	1	3rd Stage Carrier
15	13826	1	Nylon Thrust Washer
16	34342	1	2nd Stage Carrier
17	34339	1	1st Stage Carrier
18	13874	1	Sun Gear
19	28353	1	Sliding Ring Gear
20	27337	1	Gear Housing

Item	Part Number	Qty.	Description
21	-----	10	#10-24 x 2-1/4" SHCS
22	21213	1	Clutch Blockout
23	25573	1	Clutch Retainer
24	MC1213	1	Full-Voltage Pendant